



ideus™





Computer accessories / Tablet protection

400





Tablet cases butterfly

-  butterfly system
-  edges protected
-  elastic fixing
-  elastic closure rubber
-  holder mode: multiposition

* SEE MODELS IN THE FOLLOWING PAGE

SPECIFICATIONS

- Multiposition tablet with butterfly system
- Size up to 8": 215 x 153 x 18 mm
- Size up to 10.1": 263 x 193 x 18 mm
- Base: PU leather
- Lining: Microfiber
- Others: Silicone and elastic rubber

ADVANTAGES

- It protects your tablet from bumps and scratches.
- Super tough material.
- Several colors to choose from.
- Super lightweight.
- Silicone fastening.

INCLUDES

- PU leather case with butterfly system.

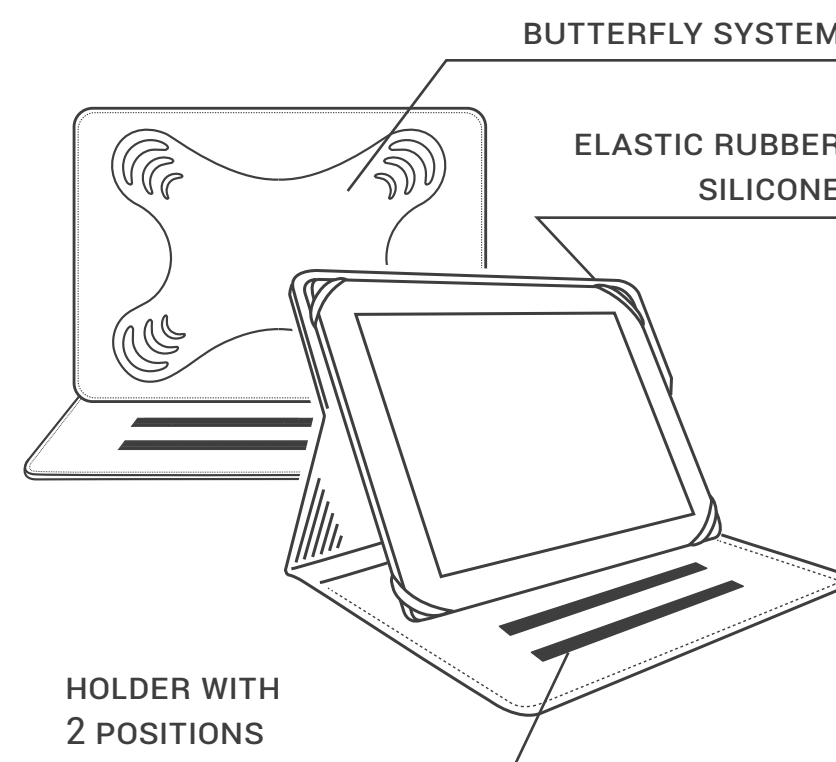

	unit per box	dimensions	total weight
Individual pack	1	217 x 20x 290 mm	370 g
Inner carton	5	125 X 328 X 235 mm	2000 g
Master carton	50	345 x 660 x 500 mm	21 kg



●	FOUNI8LEABUGN	8432471100958
●	FOUNI8LEABUOR	8432471100965
○	FOUNI8LEABUW	8432471100989



●	FOUNI10LEABUBL	8432471100859
●	FOUNI10LEABUFU	8432471100866
●	FOUNI10LEABUGN	8432471100873
●	FOUNI10LEABUOR	8432471100880
●	FOUNI10LEABUPU	8432471100897
○	FOUNI10LEABUW	8432471100910





Tablet protector universal

- total protection
- protect against fingerprints
- anti-dirt
- 5 layers protection

PPUNITAB7 7" 8432471094608

PPUNITAB10 10" 8432471094592

SPECIFICATIONS

- Universal screen protector for 7 "and 10".
- Easy placing kit.
- No more fingerprints or bubbles.

ADVANTAGES

- Your tablet screenis protected from abrasions, scratches, fingerprints or dirt on your screen.
- Tough material.
- Anti-reflection.
- Super lightweight.

INCLUDES

- 2 screen protectors
- 1 cleaning chamois



COMPOSITION OF 5 LAYERS

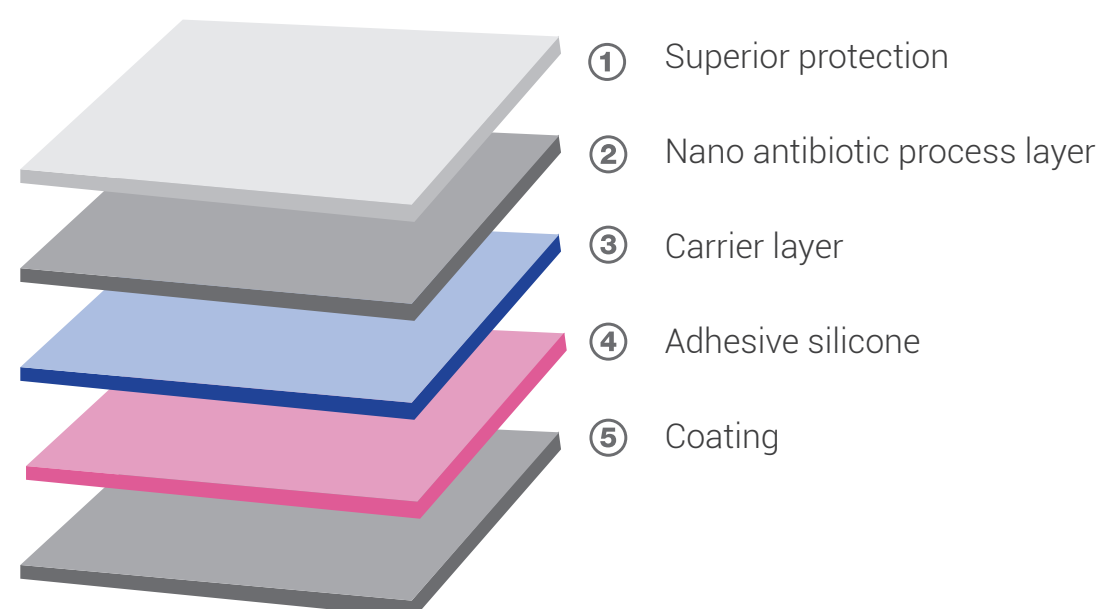

	unit per box	dimensions	total weight
Individual pack	1	210 x 2 x 300 mm	48 g
	1	160 x 2 x 240mm	70 g
Inner carton	5	250 x 15 x 350 mm	375 g
Master carton	100	430 x 420 x 250 mm	5 kg



Tempered glass protector iPad

 hardness level 9

 japanese material

 perfect view

 anti-fingerprints

 it does not peel

IPAD 9,7"	PPCRIPAD97	8432471139613
MINI 4	PPCRIPADMINI4	8432471139620
PRO 12,9"	PPCRIPADPRO129	8432471139606
PRO 9,7"	PPCRIPADPRO97	8432471139590

SPECIFICATIONS

- Tempered glass coating
- 0.33 mm of thickness.
- Hardness level 9: it is impossible to scratch the screen with metallic objects
- 5 layers of protection.

ADVANTAGES

- Ultra tough: hardness level 9.
- High-level impact absorption
- Rounded edges.
- Anti-scratch
- Anti-fingerprint. and It includes an installation kit with assembly instructions.

INCLUDES

- 1 screen protector.
- 1 cleaning chamois.
- 1 installation kit.
- 1 cleaning damp cloth.

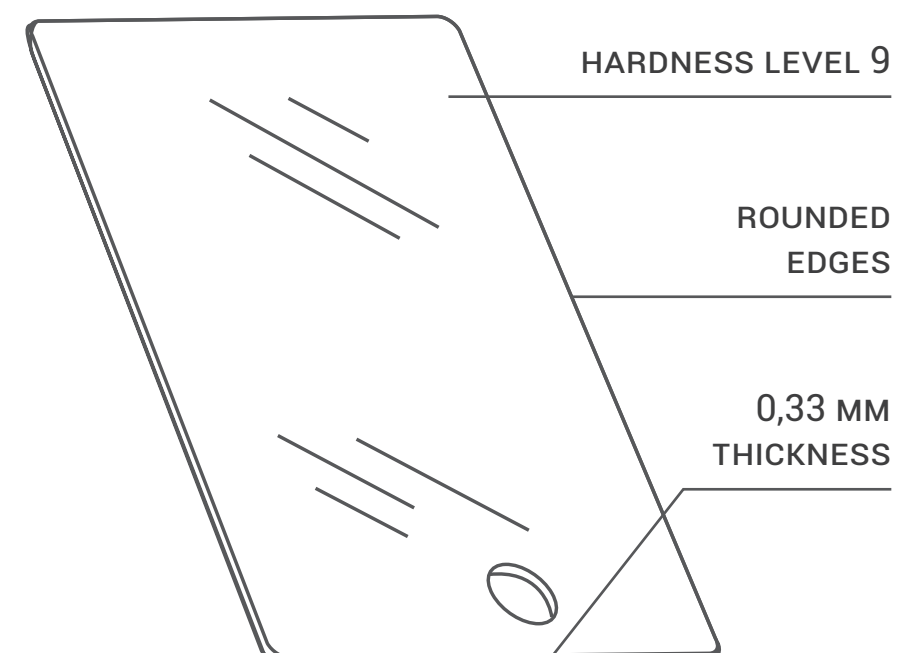

	unit per box	dimensions	total weight
Individual pack	1	-	-
Inner carton	5	-	-
Master carton	200	-	-

*Standard weights and measures of reference. Subject to slight variations depending on the model.



tablet holder

-
- padded holder
- Max/min height: 114-225 mm
- easy to install

● HOTABHRBK 8432471104000

SPECIFICATIONS

- Universal holder for tablets up to 10.1"
- Installation on headrest.
- Articulated arm with 360° rotation.
- Padded fixings.

ADVANTAGES

- Place your tablet safely in the car.
- Adjustable width and height:
Tablet thickness: 10-18 mm Max/
min height: 114-225 mm

INCLUDES

- Universal holder for tablets up to 10.1"

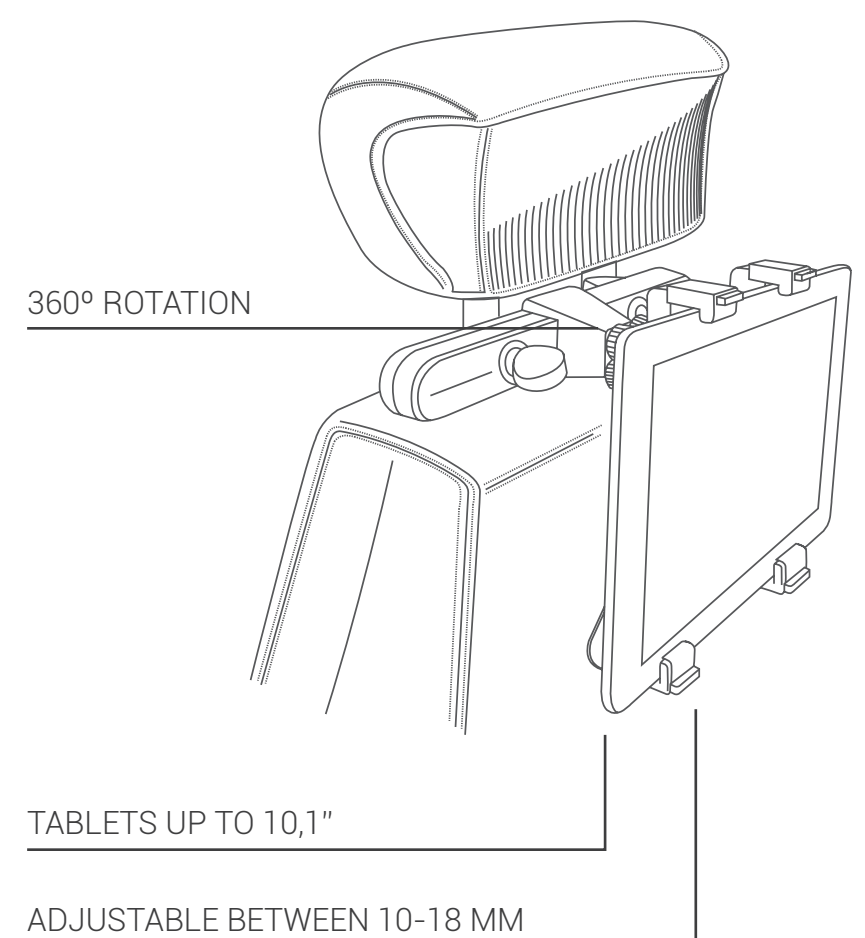

	unit per box	dimensions	total weight
Individual pack	1	105 x 210 x 15 mm	70 g
Inner carton	5	-	-
Master carton	50	-	-









ideus™

Computer accessories / Others and computers
420





Cases for Mac Books

-  total protection
-  edges protected
-  ventilation grid
-  rubbered finish
-  super thin and lightweight
-  two-pieces design

* SEE MODELS IN FOLLOWING PAGES

SPECIFICATIONS

- Two-piece protection for models: MacBook Pro Retina 13.3" and MacBook Air 13.3".
- Rubber bases for good stability.
- Rubbered finish.
- Access to all ports of the laptop.
- Ventilation grid for optimizing the temperature of the device.

ADVANTAGES

- Full protection against bumps and scratches.
- Super tough material.
- Very easy to place.
- Several colors to choose from to be able to combine them.
- Super lightweight.

INCLUDES

- Two-pieces case for MacBook.

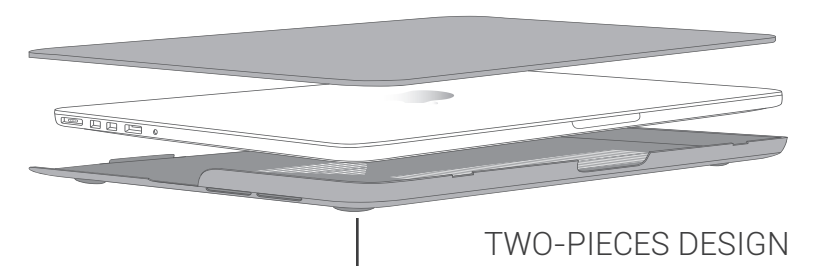

	unit per box	dimensions	total weight
Individual pack	1	340 x 235 x 25 mm	405 g
Inner carton	5	-	-
Master carton	50	-	-



- | | | |
|---|-----------------|---------------|
| ● | COBPRO13RSKRUTQ | 8432471127146 |
| ● | COBPRO13RSKRUOR | 8432471127139 |
| ● | COBPRO13RSKRUPK | 8432471126248 |
| ● | COBPRO13RSKRUGY | 8432471126231 |
| ● | COBPRO13RSKRUPU | 8432471126224 |
| ● | COBPRO13RSKRUYE | 8432471127122 |





vinyls decorative



adhesive



vinyl



easy to place

* VER MODELOS EN LA PÁGINA SIGUIENTE

SPECIFICATIONS

- Decorative vinyl for Mac Book Pro 13.3" and MacBook.
- Ultra thin thickness: 0.07 mm

ADVANTAGES

- Decorate your Mac Book with fun designs to be in the latest fashion.
- Tough material.
- Very easy to place.
- Several models to choose from.

INCLUDES

- Adhesive vinyl.
- Transparent film.
- Application card.



	unit per box	dimensions	total weight
Individual pack	1	165 x 230 mm	-
Inner carton	5	-	-
Master carton	50	-	-



● VIBAIR13ATOM 8432471134465



● VIBAIR13AX 8432471134502



● VIBAIR13BALL 8432471134458



● VIBAIR13BLUES 8432471134540



● VIBAIR13BULB 8432471134342



● VIBAIR13DRUM 8432471134410



● VIBAIR13FINGERS 8432471134526



● VIBAIR13HEADPHONE 8432471104000



● VIBAIR13KUNGFU 8432471134533



● VIBAIR13LAMP 8432471134489



● VIBAIR13LOAD 8432471134496



● VIBAIR13LP 8432471134472



● VIBAIR13MAN 8432471134335



● VIBAIR13PUSH 8432471134427



● VIBAIR13SPERM 8432471134434



● VIBAIR13TTT 8432471134519